

Features

- Single 10 dB Step
- Low Loss: 0.3 dB @ 900 MHz
- Lead-Free SOT-25 Package
- 100% Matte Tin Plating over Copper
- Halogen-Free “Green” Mold Compound
- 260°C Reflow Compatible
- RoHS* Compliant Version of AT-266

Description

The MAATSS0018 is a 1 bit, 10 dB step GaAs MMIC digital attenuator in a lead-free SOT-25 surface mount plastic package.

The MAATSS0018 is ideally suited for use where high accuracy, very low power consumption and low intermodulation products are required. Typical applications include radio, wireless LANs, GPS equipment and other gain / level control circuits.

The MAATSS0018 is a GaAs MMIC using a mature 1-micron process. The process features full chip passivation for increased performance and reliability.

Ordering Information^{1,2}

Part Number	Package
MAATSS0018	Bulk Packaging
MAATSS0018TR	1000 piece reel
MAATSS0018SMB	Sample Board

1. Reference Application Note M513 for reel size information.
2. All sample boards include 5 loose parts.

Functional Block Diagram

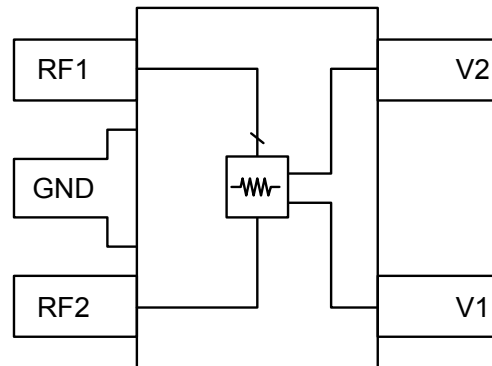

Pin Configuration

Pin No.	Function	Description
1	RF1	RF In/Out
2	GND	RF Ground
3	RF2	RF In/Out
4	V1	Control Voltage
5	V2	Control Voltage

Handling Procedures

Please observe the following precautions to avoid damage:

Static Sensitivity

Gallium Arsenide Integrated Circuits are sensitive to electrostatic discharge (ESD) and can be damaged by static electricity. Proper ESD control techniques should be used when handling these devices.

* Restrictions on Hazardous Substances, European Union Directive 2011/65/EU.

Electrical Specifications: $T_A = +25^\circ\text{C}$, $V_C = 0\text{ V} / -3\text{ V}$, $Z_0 = 50\ \Omega$

Parameter	Test Conditions	Units	Min.	Typ.	Max.
Insertion Loss	0 - 1 GHz 1 - 2 GHz	dB	—	0.3 0.5	0.45 0.7
Attenuation	DC - 2 GHz	dB	9.5	10	10.5
VSWR	0 - 2 GHz	Ratio	—	1.4:1	—
IP ₃	2 Tone @ 0 dBm, 5 MHz spacing	dBm	—	50	—
P1dB	1 GHz	dBm	—	28	—
T _{RISE} , T _{FALL}	10% to 90% RF, 90% to 10% RF	ns	—	5	—
T _{ON} , T _{OFF}	50% Control to 90% RF, 50% Control to 10% RF	ns	—	10	—
Transients	In Band	mV	—	6	—
Control Current	$ V_C = 3\text{ V}$	μA	—	25	—

Absolute Maximum Ratings^{3,4}

Parameter	Absolute Maximum
Input Power 50 MHz 500 - 2000 MHz	+27 dBm +34 dBm
Control Voltage	$-8.5\text{ V} \leq V_C \leq +8\text{ V}$
Operating Temperature	-40°C to $+85^\circ\text{C}$
Storing Temperature	-65°C to $+150^\circ\text{C}$

- Exceeding any one or combination of these limits may cause permanent damage to this device.
- MACOM does not recommend sustained operation near these survivability limits.

Truth Table^{5,6,7}

V1	V2	Attenuation State
0	1	10 dB
1	0	Insertion Loss

- For positive voltage control, external DC blocking capacitors are required on all RF ports (pins 1, 2 and 3)
- Differential voltage, $V(\text{state } 1) - V(\text{state } 0)$, must be $+2.8\text{ V}$ minimum and less than 8 V .
- $0 = -8\text{ V}$ to 0.2 V , $1 = -0.2\text{ V}$ to 8 V

Typical Performance Curves (39 pF capacitors used for positive voltage control)

Insertion Loss (Positive Control)

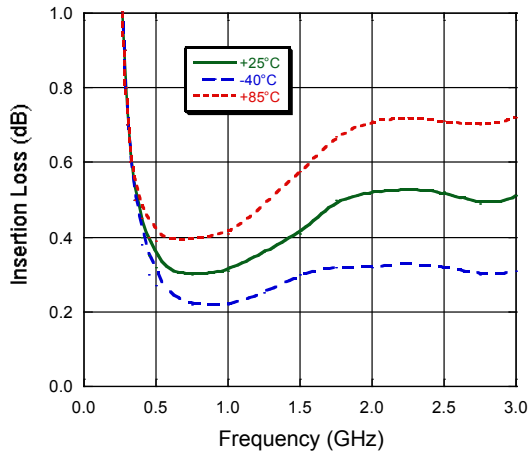

Insertion Loss (Negative Control)

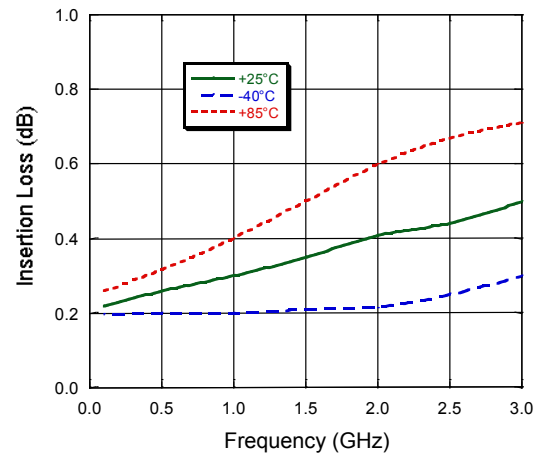

Relative Attenuation (Positive Control)

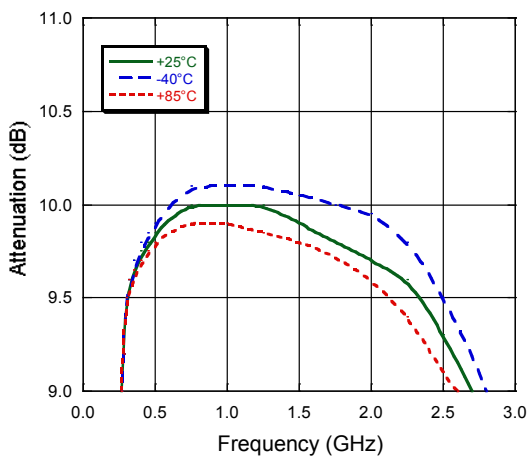

Relative Attenuation (Negative Control)

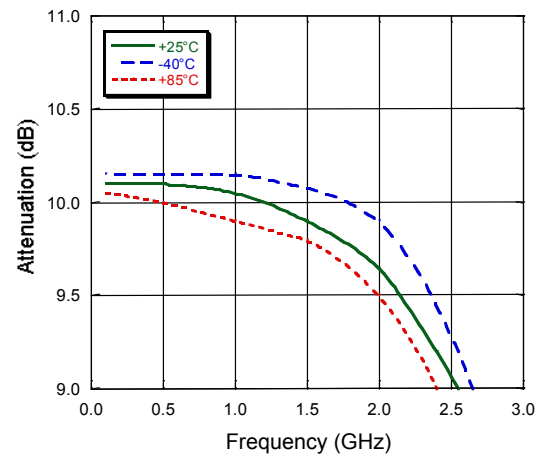

Return Loss (Reference State)

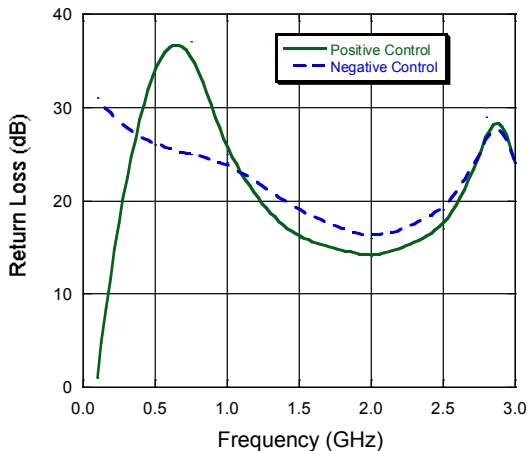

Return Loss (10 dB State)

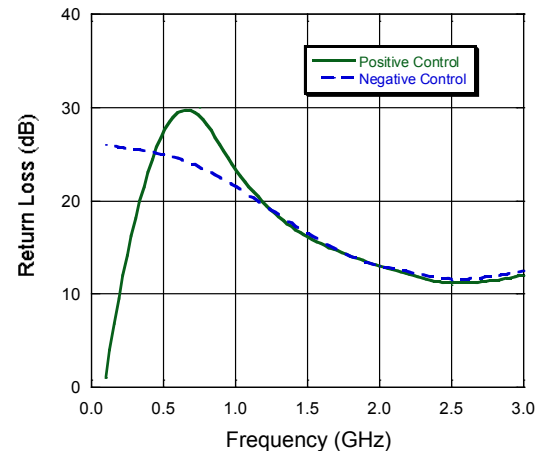

Lead-Free SOT-25[†]

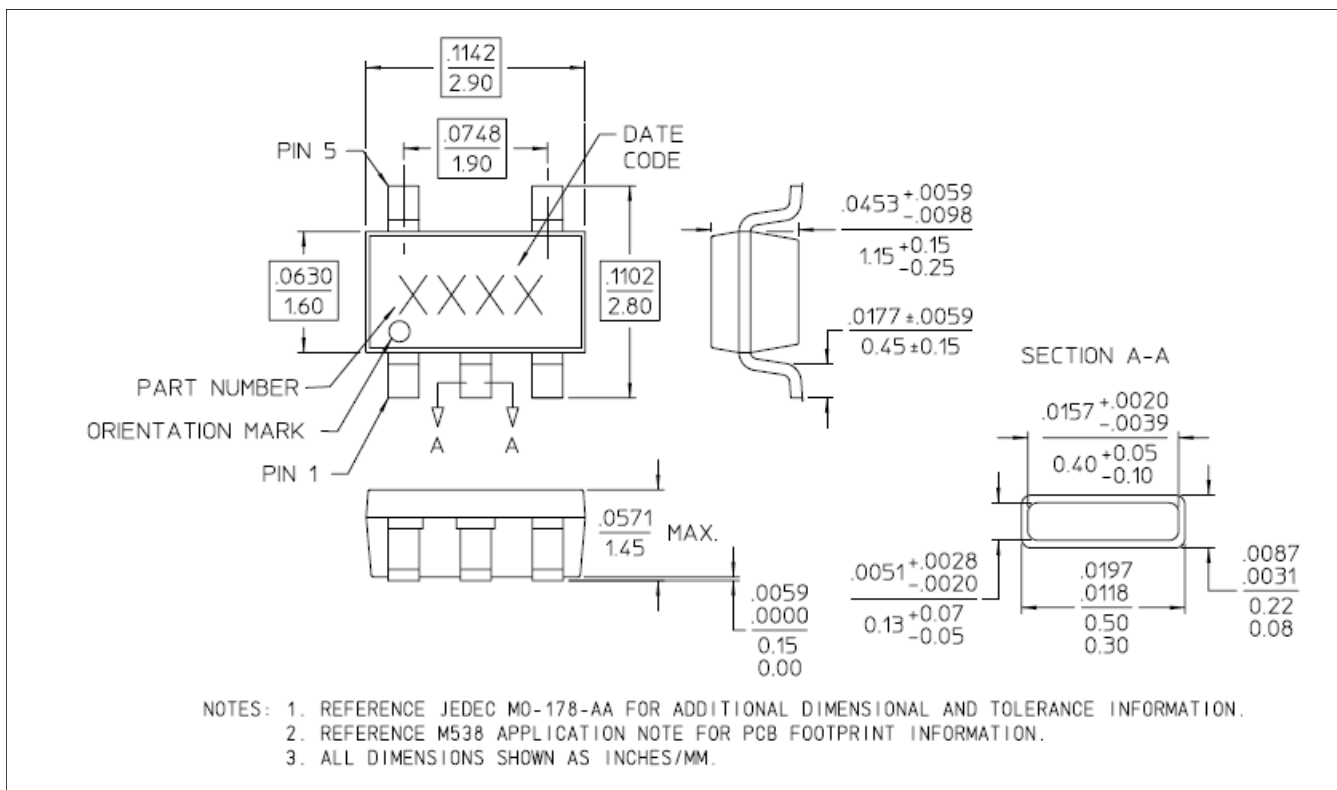

[†] Reference Application Note M538 for lead-free solder reflow recommendations.

M/A-COM Technology Solutions Inc. All rights reserved.

Information in this document is provided in connection with M/A-COM Technology Solutions Inc ("MACOM") products. These materials are provided by MACOM as a service to its customers and may be used for informational purposes only. Except as provided in MACOM's Terms and Conditions of Sale for such products or in any separate agreement related to this document, MACOM assumes no liability whatsoever. MACOM assumes no responsibility for errors or omissions in these materials. MACOM may make changes to specifications and product descriptions at any time, without notice. MACOM makes no commitment to update the information and shall have no responsibility whatsoever for conflicts or incompatibilities arising from future changes to its specifications and product descriptions. No license, express or implied, by estoppel or otherwise, to any intellectual property rights is granted by this document.

THESE MATERIALS ARE PROVIDED "AS IS" WITHOUT WARRANTY OF ANY KIND, EITHER EXPRESS OR IMPLIED, RELATING TO SALE AND/OR USE OF MACOM PRODUCTS INCLUDING LIABILITY OR WARRANTIES RELATING TO FITNESS FOR A PARTICULAR PURPOSE, CONSEQUENTIAL OR INCIDENTAL DAMAGES, MERCHANTABILITY, OR INFRINGEMENT OF ANY PATENT, COPYRIGHT OR OTHER INTELLECTUAL PROPERTY RIGHT. MACOM FURTHER DOES NOT WARRANT THE ACCURACY OR COMPLETENESS OF THE INFORMATION, TEXT, GRAPHICS OR OTHER ITEMS CONTAINED WITHIN THESE MATERIALS. MACOM SHALL NOT BE LIABLE FOR ANY SPECIAL, INDIRECT, INCIDENTAL, OR CONSEQUENTIAL DAMAGES, INCLUDING WITHOUT LIMITATION, LOST REVENUES OR LOST PROFITS, WHICH MAY RESULT FROM THE USE OF THESE MATERIALS.

MACOM products are not intended for use in medical, lifesaving or life sustaining applications. MACOM customers using or selling MACOM products for use in such applications do so at their own risk and agree to fully indemnify MACOM for any damages resulting from such improper use or sale.